



INSTRUCTION MANUAL

VHF MARINE TRANSCEIVER
IC-M200



Icom Inc.

Thank you for choosing this Icom product. This product is designed and built with Icom's state of the art technology and craftsmanship. With proper care, this product should provide you with years of trouble-free operation.

IMPORTANT

READ ALL INSTRUCTIONS carefully and completely before using the transceiver.

SAVE THIS INSTRUCTION MANUAL — This instruction manual contains important operating instructions for the **IC-M200**.

EXPLICIT DEFINITIONS

WORD	DEFINITION
⚠ DANGER!	Personal death, serious injury or an explosion may occur.
⚠ WARNING!	Personal injury, fire hazard or electric shock may occur.
CAUTION	Equipment damage may occur.
NOTE	If disregarded, inconvenience only. No risk of personal injury, fire or electric shock.

CLEAN THE TRANSCEIVER THOROUGHLY WITH FRESH WATER after exposure to saltwater, and dry it before operating. Otherwise, the transceiver's keys, switches and controllers may become unusable, due to salt crystallization.

NOTE: If the transceiver's waterproof protection appears defective, carefully clean it with a soft, wet (fresh water) cloth, then, dry it before operating. The transceiver may lose its waterproof protection if the case or connector cover is cracked or broken, or the transceiver has been dropped.

IN CASE OF EMERGENCY

If your vessel requires assistance, contact other vessels and the Coast Guard by sending a Distress call on Channel 16.

USING CHANNEL 16

DISTRESS CALL PROCEDURE

1. "MAYDAY MAYDAY MAYDAY."
2. "THIS IS" (name of vessel).
3. State Your call sign or other description of the vessel
4. "LOCATED AT" (your position).
5. State the nature of the distress and assistance required.
6. Give any other information which might facilitate the rescue.

PRECAUTIONS

⚠ **WARNING! NEVER** connect the transceiver to an AC outlet. This may pose a fire hazard or result in an electric shock.

⚠ **WARNING! NEVER** connect the transceiver to a power source of more than 16 V DC such as a 24 V battery. This could cause a fire or damage the transceiver.

⚠ **WARNING! NEVER** reverse the DC power cable polarity when connecting to a power source. This could damage the transceiver.

⚠ **WARNING! NEVER** cut the DC power cable between the DC plug at the back of the transceiver and fuse holder. If an incorrect connection is made after cutting, the transceiver may be damaged.

⚠ **WARNING! NEVER** operate the transceiver during a lightning storm. It may result in an electric shock, cause a fire or damage the transceiver. Always disconnect the power source and antenna before a storm.

CAUTION: NEVER place the transceiver where normal operation of the vessel may be hindered or where it could cause bodily injury.

DO NOT use or place the transceiver in areas with temperatures below -20°C or above $+60^{\circ}\text{C}$ or, in areas subject to direct sunlight, such as the dashboard.

DO NOT use harsh solvents such as Benzine or alcohol to clean the transceiver, as they will damage the transceiver's surfaces. If the transceiver becomes dusty or dirty, wipe it clean with a soft, dry cloth.

DO NOT disassemble or modify the transceiver for any reason.

BE CAREFUL! The transceiver rear panel will become hot when operating continuously for long periods of time.

BE CAREFUL! The transceiver and the hand microphone meet IPX7 requirements for waterproof protection. However, once the transceiver or the microphone has been dropped, waterproof protection cannot be guaranteed because of possible damage to the transceiver or microphone's case or their waterproof seals.

Keep the transceiver at least 1 m away from the ship's navigation compass.

TABLE OF CONTENTS

1. OPERATING RULES.....	1
2. PANEL DESCRIPTION.....	2
3. BASIC OPERATION.....	4
4. SCAN OPERATION.....	9
5. DUALWATCH/TRI-WATCH.....	11
6. SET MODE.....	12
7. CONNECTIONS AND MAINTENANCE	14
8. TROUBLESHOOTING	17
9. CHANNEL LIST	18
10. SPECIFICATIONS AND OPTIONS	19
INDEX.....	20

1 OPERATING RULES

◇ PRIORITIES

- Read all rules and regulations pertaining to priorities and keep an up-to-date copy handy. A Distress call takes priority over all others.
- You must monitor Channel 16 when you are not operating on another channel.
- False or fraudulent Distress signals are prohibited and punishable by law.

◇ PRIVACY

- Information overheard but not intended for you, cannot lawfully be used for any reason.
- Indecent or profane language is prohibited.

◇ RADIO LICENSES

(1) SHIP STATION LICENSE

You may require a current radio station license before using the transceiver. It is unlawful to operate a ship station which is not licensed, but required to be.

If required, contact your dealer or the appropriate government agency for a Ship-Radiotelephone license application. This government-issued license states the call sign which is your craft's identification for radio purposes.

(2) OPERATOR'S LICENSE

A Restricted Radiotelephone Operator Permit is the license most often held by small vessel radio operators when a radio is not required for safety purposes.

If required, the Restricted Radiotelephone Operator Permit must be posted or kept with the operator. If required, only a licensed radio operator may operate a transceiver.

However, non-licensed individuals may talk over a transceiver if a licensed operator starts, supervises, ends the call and makes the necessary log entries.

Keep a copy of the current government rules and regulations handy.

■ Front panel

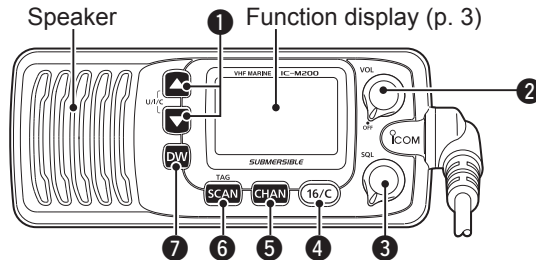

① CHANNEL UP/DOWN KEYS [▲]/[▼]•[U/I/C]

- Selects the operating channels, Set mode settings and so on. (p. 4, 12)
- Selects one of 3 channel groups in sequence when both keys are pushed. (p. 5)

② POWER/VOLUME CONTROL [VOL]

Rotate to turn the transceiver ON and OFF and adjusts the audio volume level. (p. 6)

③ SQUELCH CONTROL [SQL]

Rotate to set the squelch level. (p. 6)

- ① Rotate until the noise just disappears.

④ CHANNEL 16/CALL CHANNEL KEY [16/C]

- Push to select Channel 16. (p. 4)
- Hold down for 1 second to select call channel. (p. 4)

⑤ CHANNEL KEY [CHAN]

While pushing, push [16/C] to edit the channel name. (p. 7)

⑥ SCAN KEY [SCAN]•[TAG]

- Push to start or stop a scan. (p. 10)
- Hold down for 1 second to set or clear the displayed channel as a TAG channel. (p. 10)

⑦ DUALWATCH/TRI-WATCH KEY [DW]

Push to start or stop Dualwatch or Tri-watch. (p. 11)

■ Microphone

① PTT SWITCH [PTT]

Hold down to transmit, release to receive. (p. 6)

② CHANNEL UP/DOWN KEYS [▲]/[▼]

Push either key to change the operating channel, Set mode settings and so on. (p. 4, 12)

③ TRANSMIT POWER KEY [HI/LO]

- Push to toggle between high and low power. (p. 6)
- While holding down, turn ON the transceiver to toggle the Microphone Lock function ON or OFF. (p. 8)

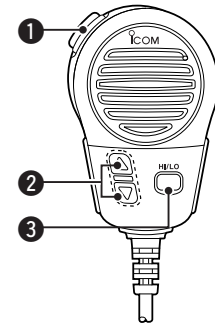

2 PANEL DESCRIPTION

■ Function display

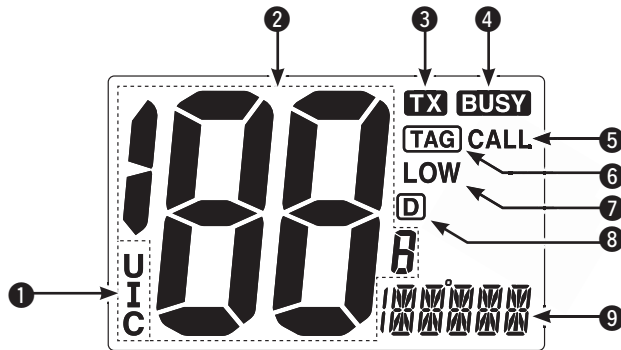

① CHANNEL GROUP ICON

Displayed when a U.S.A. “U,” International “I,” or Canadian “C” channel group is selected.

② CHANNEL NUMBER READOUT

Displays the selected channel number.

① See CHANNEL LIST (p. 18) for details.

③ TRANSMIT ICON

Displayed while transmitting.

④ BUSY ICON

Displayed when receiving a signal or when the squelch is open.

⑤ CALL CHANNEL ICON

Displayed when the Call channel is selected.
(p. 4)

⑥ TAG CHANNEL ICON

Displayed when a TAG channel is selected.
(p. 10)

⑦ LOW POWER ICON

Displayed when low power is selected.

⑧ DUPLEX ICON

Displayed when a duplex channel is selected.

⑨ CHANNEL NAME READOUT

Displays the selected channel name.

① “LOW BATTERY” scrolls when the battery voltage drops to approximately 10.8 V DC or below.

■ Selecting a channel

◇ Channel 16

Channel 16 is a Distress and safety channel. It is used to make an initial contact with a station or to make Emergency calls. Channel 16 is monitored during Dualwatch and Tri-watch. While in standby, you must monitor Channel 16.

- Push [16/C] to select Channel 16.

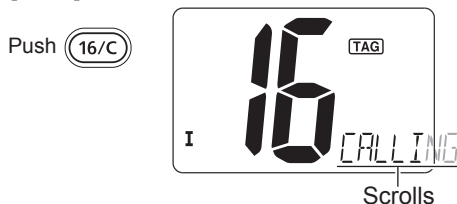

- ① Push [CHAN] to return to the screen displayed before you selected Channel 16.
- ① Push [▲] or [▼] to select an operating channel.

TIP: When the FAV on MIC function (p. 13) is ON, pushing [▲] or [▼] on the microphone sequentially selects the TAG channels in the selected channel group.

◇ Call channel

Each regular channel group has a separate Call channel (Default: Channel 9*). A Call channel is a channel that can be quickly recalled by simply pushing a key. It is monitored during Tri-watch.

* Channel 16 or any other channel may be set as the Call channel depending on the transceiver version. Ask your dealer for details.

You can set your most frequently used channel as a Call channel in each channel group. See “Setting a Call channel” (p. 7) for details.

- Hold down [16/C] for 1 second to select the Call channel of the selected channel group.
 - “CALL” and Call channel number is displayed.

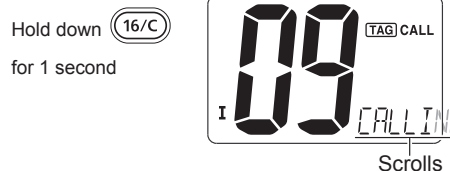

- ① Push [CHAN] to return to the screen displayed before you selected Channel 16.
- ① Push [▲] or [▼] to select an operating channel.

3 BASIC OPERATION

■ Selecting a channel (continued)

◇ USA, Canadian, and international channels

The IC-M200 has 67 USA, 67 international, and 71 Canadian preset channels.

① These channel groups may be specified for your operating area. Ask your dealer for details.

1. Push [▲] and [▼] on the transceiver at the same time.
 - USA, International, and Canadian channel groups are selected in sequence.
 - ① “U,” “I,” or “C” is displayed to the left of the channel number.
2. Push [▲] or [▼] to select your desired channel.
 - ① “D” is displayed when selecting a duplex channel.

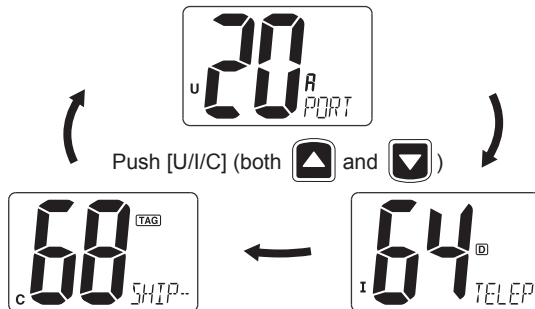

◇ 4 digit channels

The 4 digit channels are displayed as shown below. The channel number is displayed in the channel name readout (at the bottom right) and the last 2 digits are displayed in the channel number readout (center).

① The channel name cannot be displayed or entered.

Example: CH 1019



Example: CH 2078



Example: During Dualwatch or Tri-watch

① The whole channel number is not displayed.



■ Receiving and transmitting

CAUTION: Transmitting without an antenna will damage the transceiver.

1. Rotate [VOL] to turn ON the transceiver.
2. Set the audio and squelch levels.
 - Rotate [SQL] fully counterclockwise.
 - Rotate [VOL] to adjust the audio output level.
 - Rotate [SQL] clockwise until the noise just disappears.
3. Push [▲] and [▼] on the transceiver at the same time to select the desired channel group. (p. 5)
4. Push [▲] or [▼] to select a channel. (p. 4)
 - ① When receiving a signal, “BUSY” is displayed and audio is output from the speaker.
5. Push [HI/LO] on the microphone to select the output power if necessary.
 - ① “LOW” is displayed when you select low power.
 - ① Select low power for shorter distance and high power for longer distance communications.
 - ① For some channels, you can only select low power.
6. Hold down [PTT] to transmit, then speak at your normal voice level.
 - “TX” is displayed.
7. Release [PTT] to receive.

TIP: To maximize the readability of your transmitted signal at a receiver station, pause a second after pushing [PTT], and then hold the microphone 5 to 10 cm from your mouth and speak at your normal voice level.

NOTE: About the Time-out Timer (TOT) function

The TOT function inhibits continuous transmission beyond a preset time period from the transmission starts. 10 seconds before transmission is cut off, a beep sounds to indicate the transmission will be cut off, and “TOT” appears in the channel name field. Release [PTT] to end your transmission and reset the timer. You cannot transmit for 10 seconds after it is cut off.

3 BASIC OPERATION

■ Setting a Call channel

The Call channel is used to select Channel 9 (default). However, you can set another channel as the Call channel in each channel group.

1. Push [▲] and [▼] on the transceiver at the same time to select the desired channel group. (p. 5)
2. Hold down [16/C] for 1 second to select the Call channel of the selected channel group.
 - “CALL” and Call channel number is displayed.

3. Hold down [16/C] again for 3 seconds (until a long beep changes to 2 short beeps) to enter the Call Channel Set mode.
 - Channel number blinks.

4. Push [▲] or [▼] to select the desired channel.

5. Push [16/C] to set the displayed channel as the Call channel.
 - 2 short beeps sound.
 - The channel number stops blinking and the setting is saved.

① Push [CHAN] to cancel setting.

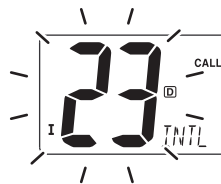
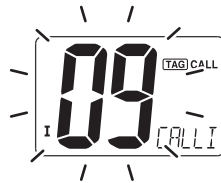

■ Entering a channel name

You can enter a channel name of up to 10 characters each. A name with more than 6 characters is scrolled after you select a channel.

- ① You cannot enter a channel name to 4 digit channels.
- ① Capital letters, small letters (except f, j, k, p, s, v, x, z), 0 to 9, some symbols (= * + - . /) and space can be used.

NOTE: Cancel Dualwatch, Tri-watch or Scan in advance.

1. Select the desired channel.
2. While holding down [CHAN], push [16/C] to edit the channel name.
 - A cursor and the first character alternately blink.
3. Push [▲] or [▼] to select the desired character.
 - ① Push [16/C] or [CHAN] to move the cursor forward or backward.
4. Repeat step 3 to enter all characters.
5. Push [DW] to save the channel name.
 - The cursor and the character stop blinking.
 - ① Push [SCAN] to cancel the editing.



■ The Microphone Lock function

The Microphone Lock function locks [▲], [▼], and [HI/LO] on the supplied microphone. The function prevents from accidentally changing channels or functions.

- While holding down [HI/LO] on the microphone, turn ON the transceiver to toggle the Microphone Lock function ON or OFF.

■ Backlight brightness level

The display and keys can be backlit for better visibility under low light conditions.

- While holding down [SCAN], push [▲] or [▼] to adjust the brightness of the display and key backlight.
 - ① The brightness level is selectable in 3 levels, or OFF.

■ The AquaQuake function

You can use the AquaQuake function to clear water away from the speaker grill. The function helps drain water away from the speaker housing by emitting a vibrating noise.

- While holding down [▲] and [▼] on the transceiver at the same time, turn ON the transceiver.
 - A low beep sounds while you hold both [▲] and [▼] to drain water, regardless of [VOL] level setting.
 - ① While the AquaQuake function is ON, key operations are disabled.
 - ① "AQUAQUAKE" scrolls.

4 SCAN OPERATION

■ Scan types

You can find ongoing calls by scanning the channels.

NOTE: Before starting a scan

- Set the channels you want to scan as TAG channels. (p. 10) (Only TAG channels are scanned.)
- Select the scan type from "Normal (default)" or "Priority." (p. 13)

NORMAL SCAN

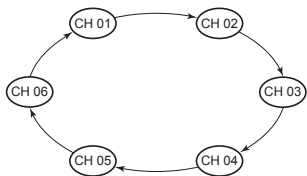

A normal scan sequentially searches through all TAG channels. However, Channel 16 is not checked unless it is set as a TAG channel.

PRIORITY SCAN

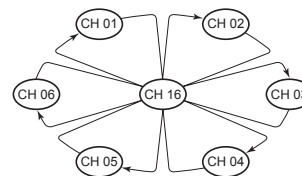

A priority scan sequentially searches through all TAG channels while also monitoring Channel 16.

When a signal is received on:

- Channel 16: The scan pauses until the signal on Channel 16 disappears.
- A channel other than Channel 16: The scan switches to Dualwatch, until the signal disappears.

■ Setting TAG channels

For more efficient scanning, you can set the desired channel as a TAG channel or remove it from the TAG channels. Channels that are not tagged will be skipped during a scan. TAG channels can be independently assigned to each channel group.

1. Push [▲] and [▼] on the transceiver at the same time to select the desired channel group.
2. Select the desired channel to be set as a TAG channel.
3. Hold down [SCAN] for 1 second to set the displayed channel as a TAG channel.
 - “[TAG]” is displayed.
 - ① To clear the TAG channel setting, repeat step 3.
 - “[TAG]” disappears.

TIP: Clearing (or setting) all TAG channels

While holding down [HI/LO] on the microphone, push [SCAN] for 3 seconds (until a long beep changes to 2 short beeps) to clear all TAG channels in the selected channel group.

- ① Repeat the procedure to set all channels as TAG channels.

■ Starting a scan

NOTE: Select the scan type from "Normal (default)" or "Priority." (p. 13)

1. Push [▲] and [▼] on the transceiver at the same time to select the desired channel group.
2. Set the TAG channels as described to the left.
3. Confirm the squelch is closed to start a scan.
4. Push [SCAN] to start a Priority or Normal scan.
 - “ \overline{SC} ” blinks during a Priority scan, “ \overline{SCAN} ” blinks during a Normal scan.
 - ① When a signal is detected, scan pauses until the signal disappears or resumes after pausing 5 seconds, according to the Scan resume timer setting. (p. 13) (Channel 16 is still monitored during Priority scan.)
 - ① Push [▲] or [▼] to check the scanning TAG channels, to change the scanning direction or resume the scan manually.
 - ① A beep sounds and “ \overline{SC} 16” blinks when a signal is received on Channel 16 during Priority scan.
5. Push [SCAN] again to stop the scan.

5

DUALWATCH/TRI-WATCH

Dualwatch and Tri-watch are convenient to monitor Channel 16 while you are operating on another channel.

DUALWATCH/TRI-WATCH SIMULATION

Monitors Channel 16 while receiving on another channel.
(example: CH 88A)

Dualwatch

Monitors Channel 16 and the Call channel while receiving on another channel.
(example: CH 88A)

Tri-watch

When a signal is received on:

- Channel 16: Dualwatch/Tri-watch pauses on Channel 16 until the signal disappears.
- On the Call channel: Tri-watch switches to Dualwatch until the signal on the Call channel disappears.

NOTE: Select Dualwatch or Tri-watch in the Set mode. (p. 13)

1. Select the desired channel.
2. Push [DW] to start Dualwatch or Tri-watch.
 - “DW” blinks during Dualwatch. “TW” blinks during Tri-watch.
 - A beep sounds when a signal is received on Channel 16.
3. Push [DUAL] (SCAN) again to cancel Dualwatch or Tri-watch.

[Example]: Tri-watch on INT channel 25

1. Push [DW] to start Tri-watch.
2. Signal is received on the Call channel.
3. A signal is received on Channel 16 takes priority.
4. Tri-watch resumes after the signal disappears.



■ Set mode

In the Set mode, you can change the settings of the transceiver's functions.

NOTE: Available functions may differ depending on the dealer setting. Ask your dealer for details.

◇ Set mode operation

1. Turn OFF the transceiver.
2. While holding down [16/C], turn ON the transceiver.
 - Enters the Set mode.
 - "SCAN" is displayed.
3. Push [16/C] several times until your desired item is selected.
4. Push [▲] or [▼] to change the setting.
5. Turn OFF the transceiver, then ON again to exit the Set mode.

◇ Set mode sequence

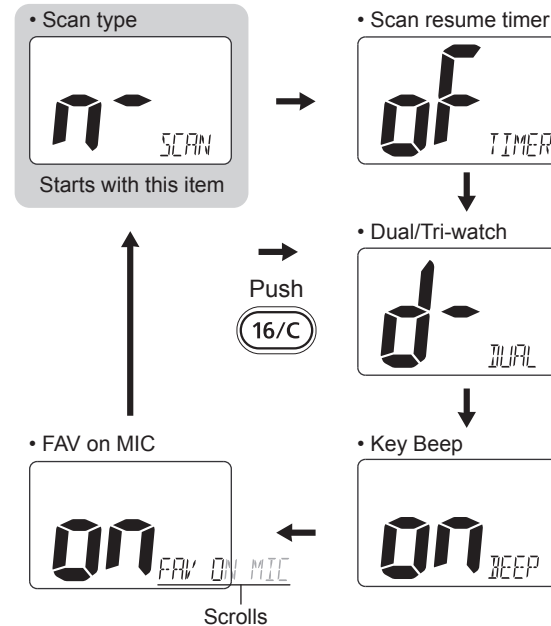

6 BASIC OPERATION

■ Set mode items

Push[▲] or [▼]to change the setting

◇ Scan type

Select whether to start the Normal scan or Priority scan after pushing [SCAN]. (p. 10)



Normal scan (default)



Priority scan

◇ Scan resume timer

When the function is ON, the scan pauses for 5 seconds and resumes even if a signal has been received on any channel other than Channel 16. (p. 10)



Scan timer OFF (default)



Scan timer ON

◇ Dual/Tri-watch

Select whether to start Dualwatch or Tri-watch after pushing [DW]. (p. 11)



Dualwatch (default)



Tri-watch

◇ Key Beep

Turn the key beep ON or OFF.



Beep ON (default)



Beep OFF

◇ FAV on MIC

When the function is ON, [▲] or [▼] on the microphone select only the TAG channels in the selected channel group in sequence.

① “FAV ON MIC” scrolls in the lower right corner.



FAV on MIC ON (default)



FAV on MIC OFF

■ Connections

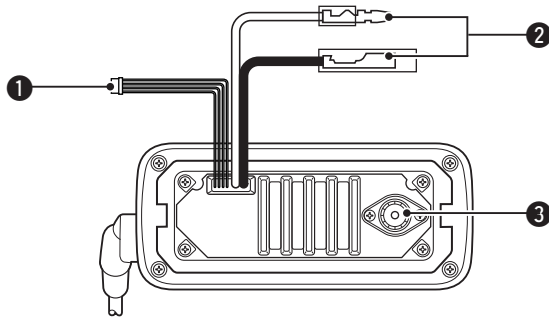

① AF OUT LEADS

Blue: External Speaker (+)

Gray: External Speaker (-)

Connects to an external speaker.

Yellow: Data line

Green: Data line

Used only for maintenance purposes.

NOTE: AF out leads

The connectors are attached to keep the leads together. Before connecting to a piece of equipment, cut the leads to remove the connectors, if desired.

② DC POWER CONNECTORS

Connects the supplied DC power cable to an external 13.8 V DC power source.

CAUTION: After connecting the DC power cable and external speaker lead, cover the connector and leads with an vulcanizing tape, as shown below, to prevent water seeping into the connector.

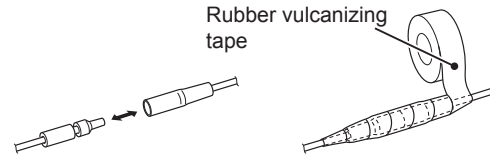

③ ANTENNA CONNECTOR

Connects to a marine VHF antenna.

CAUTION: Transmitting without an antenna may damage the transceiver.

7 CONNECTIONS AND MAINTENANCE

■ Supplied accessories

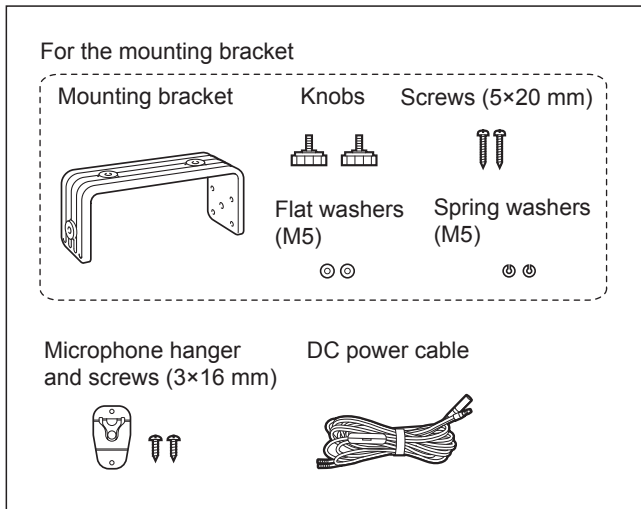

■ Antenna

A key element in the performance of any communication system is the antenna. Ask your dealer about antennas and the best place to mount them.

■ Replacing a fuse

If a fuse blows, or the transceiver stops functioning, find and repair the cause of the problem. Then replace the damaged fuse with a new, adequately rated fuse.

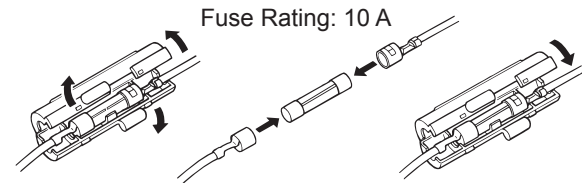

■ Cleaning

If the transceiver becomes dusty or dirty, wipe it clean with a dry, soft cloth.



DO NOT use harsh solvents such as Benzine or alcohol when cleaning, because they will damage the transceiver surfaces.

■ Mounting the transceiver

The universal mounting bracket supplied with your transceiver enables dashboard or overhead mounting.

- Mount the transceiver firmly with the 2 supplied screws (5×20 mm) on only a flat hard board that the screws won't penetrate.
- Mount the transceiver so that the face of the transceiver is at 90° to your line of sight when operating it.

CAUTION: KEEP the transceiver and microphone at least 1 meter away from your vessel's magnetic navigation compass.

NOTE: Adjust the angle to make the function display easy to read.

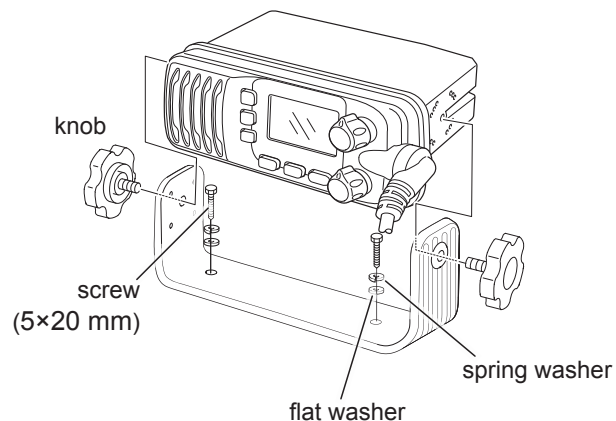

8

TROUBLESHOOTING

PROBLEM	POSSIBLE CAUSE	SOLUTION	REF.
Power does not come on when turning ON the transceiver.	Power cable is improperly connected.	Reconnect the DC power cable correctly.	p. 14
No sound is heard from the speaker.	Volume level is too low.	Rotate [VOL] to a suitable listening level.	p. 6
	Speaker has been exposed to water.	Drain water from the speaker.	p. 8
	Squelch level is too high.	Set squelch to the threshold point.	p. 6
Cannot transmit or output power is low.	Channels that are only for receive or low power are selected.	Select other channels.	p. 18
	Low power is selected.	Push [HI/LO] on the microphone to select high power.	p. 6
Scan does not start.	“TAG” channels are not set.	Set the channels you want to scan as “TAG” channels.	p. 10
No beeps.	Key beeps are OFF.	Turn ON the key beep in the Set mode.	p. 13

CHANNEL LIST

9

Channel number			Frequency (MHz)	
USA	INT	CAN	Transmit	Receive
	01	01	156.050	160.650
01A			156.050	156.050
	02	02	156.100	160.700
	03	03	156.150	160.750
03A			156.150	156.150
	04		156.200	160.800
		04A	156.200	156.200
	05		156.250	160.850
05A		05A	156.250	156.250
06	06	06	156.300	156.300
	07		156.350	160.950
07A		07A	156.350	156.350
08	08	08	156.400	156.400
09	09	09	156.450	156.450
10	10	10	156.500	156.500
11	11	11	156.550	156.550
12	12	12	156.600	156.600
13 ^{*2}	13	13 ^{*1}	156.650	156.650
14	14	14	156.700	156.700
15 ^{*2}	15 ^{*1}	15 ^{*1}	156.750	156.750
16	16	16	156.800	156.800
17 ^{*1}	17	17 ^{*1}	156.850	156.850
	18		156.900	161.500
18A		18A	156.900	156.900
	19		156.950	161.550
19A		19A	156.950	156.950
20	20	20 ^{*1}	157.000	161.600
20A			157.000	157.000

Channel number			Frequency (MHz)	
USA	INT	CAN	Transmit	Receive
	21	21	157.050	161.650
21A		21A	157.050	157.050
		21b	Rx only	161.650
	22		157.100	161.700
22A		22A	157.100	157.100
	23	23	157.150	161.750
23A			157.150	157.150
24	24	24	157.200	161.800
25	25	25	157.250	161.850
		25b	Rx only	161.850
26	26	26	157.300	161.900
27	27	27	157.350	161.950
28	28	28	157.400	162.000
		28b	Rx only	162.000
	60	60	156.025	160.625
	61		156.075	160.675
61A		61A	156.075	156.075
	62		156.125	160.725
		62A	156.125	156.125
	63		156.175	160.775
63A			156.175	156.175
	64	64	156.225	160.825
64A		64A	156.225	156.225
	65		156.275	160.875
65A	65A	65A	156.275	156.275
	66		156.325	160.925
66A	66A	66A ^{*1}	156.325	156.325
67 ^{*2}	67	67	156.375	156.375

Channel number			Frequency (MHz)	
USA	INT	CAN	Transmit	Receive
68	68	68	156.425	156.425
69	69	69	156.475	156.475
71	71	71	156.575	156.575
72	72	72	156.625	156.625
73	73	73	156.675	156.675
74	74	74	156.725	156.725
75 ^{*1}	75 ^{*1}	75 ^{*1}	156.775	156.775
76 ^{*1}	76 ^{*1}	76 ^{*1}	156.825	156.825
77 ^{*1}	77	77 ^{*1}	156.875	156.875
	78		156.925	161.525
78A		78A	156.925	156.925
	79		156.975	161.575
79A		79A	156.975	156.975
	80		157.025	161.625
80A		80A	157.025	157.025
	81		157.075	161.675
81A		81A	157.075	157.075
	82		157.125	161.725
82A		82A	157.125	157.125
	83	83	157.175	161.775
83A		83A	157.175	157.175
		83b	Rx only	161.775
84	84	84	157.225	161.825
84A			157.225	157.225
85	85	85	157.275	161.875
85A			157.275	157.275
86	86	86	157.325	161.925
86A			157.325	157.325

Channel number			Frequency (MHz)	
USA	INT	CAN	Transmit	Receive
87	87	87	157.375	161.975
87A			157.375	157.375
88	88	88	157.425	162.025
88A			157.425	157.425

Channel number		Frequency (MHz)	
USA/INT/CAN	Transmit	Receive	
	1019	156.950	156.950
	1020	157.000	157.000
	1078	156.925	156.925
	1079	156.975	156.975
	2019	161.550	161.550
	2020	161.600	161.600
	2078	161.525	161.525
	2079	161.575	161.575

*1 Low power only. *2 Momentary high power.

NOTE: Simplex channels, 3, 21, 23, 61, 64, 81, 82 and 83 **CANNOT** be lawfully used by the general public in U.S.A. waters.

8
9

10 SPECIFICATIONS AND OPTIONS

■ Specifications

General

- Frequency coverage:
 - Transmit 156.025~162.000 MHz
 - Receive 156.025~162.025 MHz
- Type of emission : FM (16K0G3E)
- Antenna impedance : 50 Ω nominal
- Operating temperature range:
 - 20°C to +60°C
- Power supply voltage (negative ground):
 - 13.8 V DC
- Current drain (at 13.8 V):
 - TX (at 25 W) 5.5 A maximum
 - Maximum audio 1.5 A maximum
- Dimensions: 153(W) \times 67(H) \times 133(D) mm
- Weight (approximately): 790 g

Transmitter

- Rated output power: 25 W (High) and 1 W (Low)
- Modulation: Variable reactance frequency modulation
- Maximum frequency deviation:
 - ± 5.0 kHz
- Frequency tolerance: ± 5.0 ppm
- Spurious emissions: Less than -70 dBc (High)
Less than -56 dBc (Low)
- Adjacent channel power: More than 70 dB
- Audio harmonic distortion (at 60% deviation):
 - Less than 10%
- Residual modulation: More than 40 dB

Receiver

- Intermediate frequencies: 1st 21.7 MHz, 2nd 450 kHz
- Sensitivity (12 dB SINAD): -121 dBm typical
- Squelch sensitivity: Less than -117 dBm
- Audio power output (at 10% distortion into 4 Ω):
 - 4.5 W typical
- Adjacent channel selectivity: More than 70 dB
- Spurious response: More than 70 dB
- Intermodulation: More than 70 dB
- Hum and noise: More than 40 dB

■ Options

- **MB-69** FLUSH MOUNT KIT
- **MB-92** DUST COVER

Approved Icom optional equipment is designed for optimal performance when used with an Icom transceiver.

Icom is not responsible for the destruction or damage to the Icom transceiver, if the malfunction is because of:

- Force majeure, including, but not limited to, fires, earthquakes, storms, floods, lightnings, or other natural disasters, disturbances, riots, war, or radioactive contamination.
- The use of Icom transceiver with any equipment that is not manufactured or approved by Icom.

4 digit channels.....	5	Lock function	8	TAG channel	
Accessories	15	Low power	6	Clearing.....	10
AF out lead	14	Microphone.....	2	Setting.....	10
Antenna	15	Microphone Lock function.....	8	Time-out Timer	6
Antenna connector	14	Mounting.....	16	TOT	6
AquaQuake function	8	Options	19	Transmitting	6
Audio output level.....	6	Output power.....	6	Tri-watch.....	11, 13
Backlight.....	8	Receiving.....	6	Troubleshooting	17
Call channel.....	4	Scan			
Setting.....	7	Normal scan.....	9		
Channel		Priority scan	9		
Channel 16.....	4	Starting a scan	10		
Channel group	5	Scan type	9		
Channel list	18	Scan resume timer.....	13		
Channel name, Entering	7	Set mode	12		
Channel, Selecting.....	4	Items	13		
Cleaning	i, 15	Dual/Tri-watch	13		
Connections.....	14	FAV on MIC	13		
DC power connector.....	14	Key Beep.....	13		
Display.....	3	Scan resume timer	13		
Distress call	i	Scan type	13		
Dualwatch.....	11, 13	Operation	12		
Emergency	i	Sequence	12		
Front panel	2	Specifications	19		
Function display.....	3	Squelch.....	6		
Fuse, Replacing.....	15	Supplied accessories.....	15		
High power	6				

Count on us!

A-7299H-1EX
Printed in Japan
© 2016 Icom Inc.

Icom Inc.
1-1-32 Kamiminami, Hirano-ku, Osaka 547-0003, Japan