

Pro Installer Link Bars

- A range of linking bars to complement the Pro Installer range of products
- High purity copper, tin plated for optimum marine electrical performance
- Fastest, most economic way of connecting products
- Saves space, allows clustering for the most compact installations
- Links can be doubled for higher loads

Choosing a Link Bar

Step 1: Use selection guide on the following pages to determine the correct link bar.

Step 2: If multiple options exist, see diagrams for layout options.

Step 3: Find the part below or on page 53.

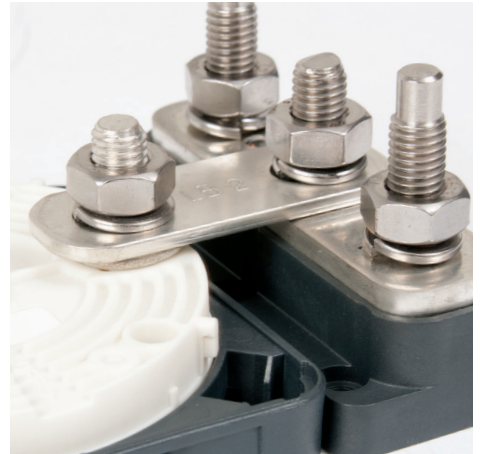

Actual Size



LB-1 (marking)
OEM # 779-LB-1-B 5/pkg



LB-2 (marking)
OEM # 779-LB-2-B 5/pkg



LBJ-2 (marking)
OEM # 779-LBJ-2-B 5/pkg



LBZ-1 (marking)
OEM # 779-LBZ-1-B 5/pkg



LBZ-2 (marking)
OEM # 779-LBZ-2-B 5/pkg

See page 53 for amp ratings, and dimensions.

Pro Installer Link Bars

Diagrams

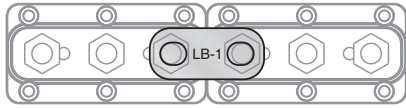

E:E End to End linking

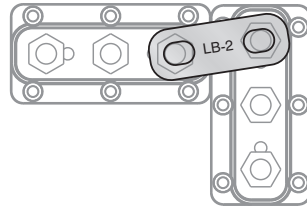

S:E Side to End linking

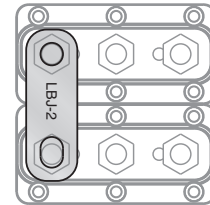

S:S Side to Side joining

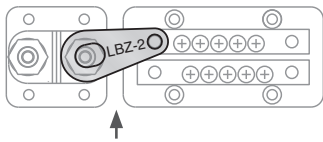

Gap For small gaps between products

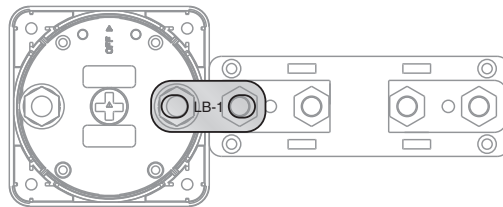

C: Centerline linking

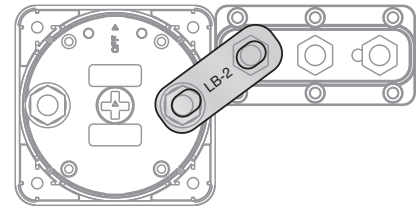

O: Offset linking

Side to Side Joining
on following page

Linking Selection Guide

	3, 4, 5, & 8 Stud Heavy Duty Bus Bars	10 & 18 Way Z Bus Bars	778-ANL Fuseholder	ANL Through Panel Fuseholder	ANL & Class T Double Stud Fuseholders	Single Insulated Studs	Double Insulated Studs	EZ Mount Battery Switch On/Off
Bus Bars								
3, 4, 5, & 8 Stud Heavy Duty Bus Bars	LB-1	LBZ-2	LB-1	—	LB-1 (4 Stud Gap)	LB-2	S:E LB-1 Gap LB-1	O: LB-2 C: LB-1
10 & 18 Way Z Bus Bars	LBZ-2	LBZ-1	LBZ-2	—	LBZ-2	—	Gap LBZ-2	LBZ-2
Fuseholders								
778-ANL Fuseholder	LB-1	LBZ-2	LB-2	—	LB-1	LB-2	S:E LB-1 Gap LB-1	O: LB-2 C: LB-1
ANL Through Panel Fuseholder	—	—	—	LB-2	—	—	—	—
ANL & Class T Double Stud Fuseholders	LB-1	LBZ-2	LB-1	—	LB-1	LB-2	S:E LB-1 Gap LB-1	O: LB-2 C: LB-1
Insulated Studs								
Single Insulated Studs	LB-2	—	LB-2	—	LB-2	LBJ-2	LB-1	LBJ-2 C: LB-2
Double Insulated Studs	S:E LB-1 Gap LB-1	Gap LBZ-2	S:E LB-1 Gap LB-1	—	S:E LB-1 Gap LB-1	LB-1	S:S LBJ-2 Gap LB-1	O: LB-1 C: Gap LB-1
EZ Mount Battery Switches								
EZ Mount Battery Switch On/Off	O: LB-2 C: LB-1	LBZ-2	O: LB-2 C: LB-1	—	O: LB-2 C: LB-1	O: LBJ-2 C: LB-2	O: LB-1 C: Gap LB-1	LB-1
EZ Mount Selector Battery Switch - "Battery" Studs	LB-2 (4 Stud LB-1)	LBZ-2	LB-2	—	O: LB-1 C: LB-2	LBJ-2	LB-1	—
EZ Mount Selector Battery Switch - "Common" Stud	O: LB-2 C: LB-1	LBZ-2	O: LB-2 C: LB-1	—	O: LB-2 C: LB-1	O: LBJ-2 C: LB-2	O: LB-1 C: Gap LB-1	—

See pages 46–50 for the full line of Pro Installer Bus Bars, Fuseholders and Insulated Studs.

Side to Side Joining Selection Guide

	Marking	OEM #	Qty
Joining 2 products	LBJ-2	779-LBJ-2-B	5/pkg
Joining 3 products	LBJ-3	779-LBJ-3-B	1/pkg
Joining 4 products	LBJ-4	779-LBJ-4-B	1/pkg
Joining 5 products	LBJ-5	779-LBJ-5-B	1/pkg
Joining 6 products	LBJ-6	779-LBJ-6-B	1/pkg

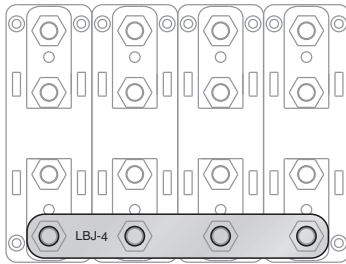

NOT Actual Size

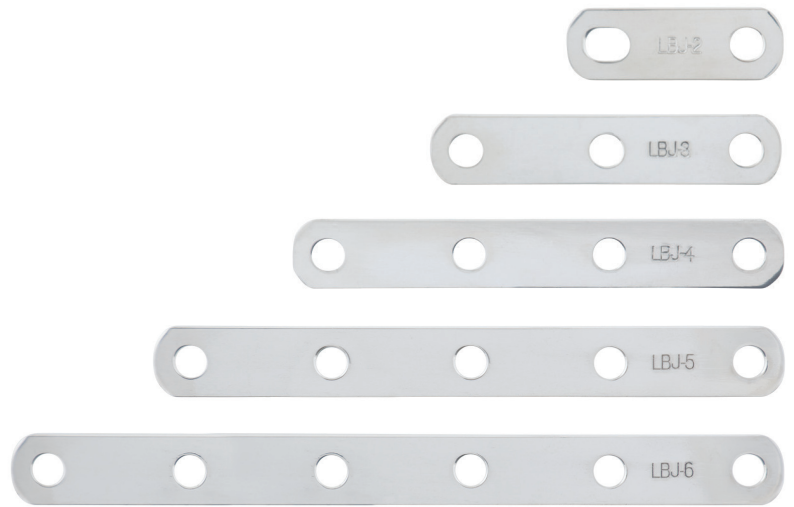

Specifications

Marking	Part #	OEM #	Pkg Qty	Description	Function	Max Amps	L x W in	L x W mm
LB-1	—	779-LB-1-B	5	Link Bar 31-34.7 mm	Short Link Bar 8 & 10 mm studs	650	2.2" x 1.0"	56x25
LB-2	—	779-LB-2-B	5	Link Bar 35.5-42.5 mm	Medium Link Bar 8 & 10 mm studs	650	2.8" x 1.0"	69x25
LBJ-2	—	779-LBJ-2-B	5	Joiner 2-way 46-50 mm	Long Link Bar 8 & 10 mm studs	650	3.0" x 1.0"	74x25
LBZ-1	—	779-LBZ-1-B	5	Link Z Bar to Z Bar	Joins Z Bars End to End, Back to Back	250	2.0" x 0.5"	49x12
LBZ-2	—	779-LBZ-2-B	5	Link Z Bar to Bus Bar or F-holder	Joins Z Bars to Bus Bars or F-holders	400	2.1" x 1.0"	53x25
LBJ-2	779-LBJ-2	779-LBJ-2-B	1	Joiner 2-way	Side to Side joiner 2 products	650	3.0" x 1.0"	74x25
LBJ-3	779-LBJ-3	779-LBJ-3-B	1	Joiner 3-way	Side to Side joiner 3 products	525	4.9" x 1.0"	123x25
LBJ-4	779-LBJ-4	779-LBJ-4-B	1	Joiner 4-way	Side to Side joiner 4 products	450	6.9" x 1.0"	172x25
LBJ-5	779-LBJ-5	779-LBJ-5-B	1	Joiner 5-way	Side to Side joiner 5 products	400	8.8" x 1.0"	221x25
LBJ-6	779-LBJ-6	779-LBJ-6-B	1	Joiner 6-way	Side to Side joiner 6 products	350	10.8" x 1.0"	270x25

Link Bar Sets

Part #	Pkg Qty	Description	Contains
779-LB-EES	2	Link Bar End: End Set	1x LB-1, 1x LB-2
779-LB-ZS	2	Link Bar Z Bus Bar Set	1x LBZ-1, 1x LBZ-2
779-LB-BSS	4	Link Bar Battery Switch Set	1x LB-1, 3x LB-2

Best Electrical Practice for High Loads:

- Supply power to the center of link bars or bus bars to balance loads
- Connect highest loads directly/closest to the supply cable

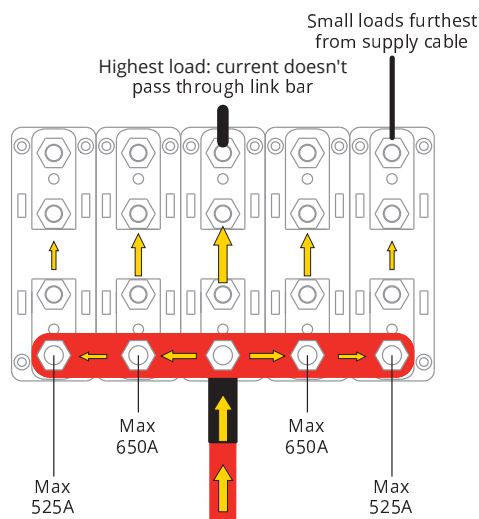

Note: Link bars can be doubled to increase load capacity

